

REGULATORS BOSCH

IRBO-033001 24V.



BOSCH
0-192-033-001,
0-192-033-002,
0-192-033-004
FORD
11635831
LUCUS
21931016,
NCB 407
TRANSPO IB033

IRBO-052015 12V. 28 MM. Slip Ring



WAI 35-9104
TRANSPO IB352

BOSCH
1-192-052-015,
1-192-052-016,
1-192-052-021,
1-192-052-024,
1-192-052-027,
1-192-052-029,
1-197-311-004,
1-197-311-005,
1-197-311-006,
1-197-311-010,
1-197-311-012,
1-197-311-013,
1-197-311-021

IRBO-311003 12V. 28 MM. Slip Ring



AUDI
068 903 803D
TRANSPO IB354

BMW
1711391,
1231 1279 548,
1232 1271 644,
1232 1711 399
BOSCH
1-197-311-003,
1-197-311-007,
1-197-311-009,
1-197-311-022,
1-197-311-023,
1-197-311-050

IRBO-311301 24V. 28 MM. Slip Ring



BOSCH 1-197-311-301,
1-197-311-310
MERCEDES-BENZ
000-154-1705
WAI 35-9188
TRANSPO IB362

IRBO-052001 12V. 32 MM. Slip Ring



FORD
1477502,
71BB-10316-AA
MERCEDES-BENZ
002-154-0606,
002-154-1806
TRANSPO IB350
BOSCH 0-192-052-001,
0-192-052-002, 0-192-052-004,
0-192-052-005, 0-192-052-006,
0-192-052-008, 0-192-052-011

IRBO-053003 24V. 28 MM. Slip Ring



BOSCH
1-192-053-003
1-192-053-009
1-192-053-012
TRANSPO IB381

IRBO-382 24V. 28 MM. Slip Ring



BOSCH OE-PART
-REFERENCES NOT
AVAILABLE

IRBO-067018 12V. 28 MM. Slip Ring

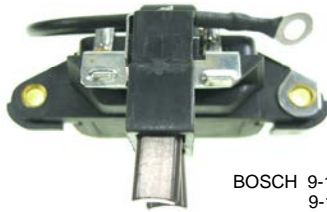

BOSCH 9-190-067-018,
9-120-060-023
TRANSPO IB392

IRBO-087005 24V. 32 MM. Slip Ring

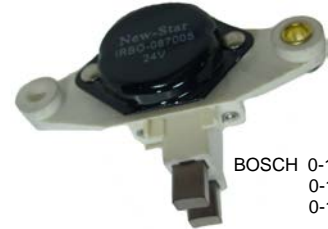

BOSCH 0-192-052-001
0-192-052-002
0-192-052-003

IRBO-311211 12V. 14 MM. Slip Ring



VOLVO
3-544-570
BOSCH
1-197-311-211,
1-197-311-213,
1-197-311-217
1-197-311-219
MERCEDES-BENZ
002-154-8106,
002-154-8206,
002-154-8506,
002-154-8706
WAI 35-9109
TRANSPO IB387

IRBO-311212 12V. 14 MM. Slip Ring



BOSCH
1-197-311-212
1-197-311-214
1-197-311-220
WAI 35-9108
TRANSPO IB385

IRBO-145225 12V. 28 MM. Slip Ring



BOSCH
0124215006 0124225012
0124315001 0124315002
0124315003 0124315004
0124315005 0124315006
0124315007 0124315008
0124315011 0124315012
0124315013 0124315018

IRBO-145231 12V.



BOSCH
0124225001
0124225002
0124225004
0124225009
0124225018
0124225022

IRBO-343 12V.

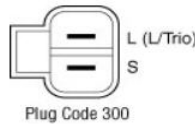

BOSCH
9191067043

IRBO-298 24V.

MERCEDES-BENZ 0001542705
SCANIA 1501245
TRANSPO IB298

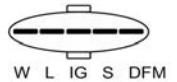

BOSCH
F00M 145256
F00M145298
F00M 145302
F00M145307
F00M145237
F00M145299
IB298

IRBO-1028 12V.















IRBO-311516 12V.

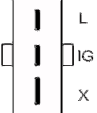

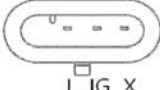

















A-Circuit,FR-L-LG
Terminals,14.4Vset
BOSCH
1197311506 1197311516
1197311536 1197311545
1197311557 1 197 311 506
1 197 311 516 1 197 311 536
1 197 311 545 1 197 311 557
BMW 12311713491
CARGO 138999
MOBILETRON VRB238
TRANSPO IB545

REGULATORS DELCO

<p>IRDC-6411 12V.</p>  <p>DELCO 1116411,1116429, 1116436,1116437, D677,D685,D698 WAI 35-118 35-127 TRANSP0 D411</p>	<p>IRDC-6432 12V.</p>  <p>DELCO 1116432, 1101219, GM10463134 OPEL 321-425 TRANSP0 D432</p>	<p>IRDC-101 12V.</p>  <p>LUCAS 21226042, 21226061 WAI 35-101 TRANSP0 D101HD DELCO 1116380,1116384, 1116385,1116387 BOSCH 0 986 192 000</p>
<p>IRDC-102 12V.</p>  <p>DELCO 1116406, 1894489, D672 WAI 35-103 TRANSP0 D102HD</p>	<p>IRDC-104 24V.</p>  <p>DELCO 1116404, 1116405, 1894460 WAI 35-106, 35-106-1 TRANSP0 D104HD</p>	<p>IRDC-105 12V.</p>  <p>DELCO 1988988 WAI 35-102 TRANSP0 D105HD</p>
<p>IRDC-276010</p>   <p>DELCO 276010 MOBILETRON VR-D276 CARGO 139467 DAEWOO 276010 TRANSP0 D403</p>	<p>IRDC-2000</p> 	<p>IRDC-020 12V.</p>   <p>A-Circuit Voltage Set Point 14.70V For use on: 11SI Alternator FOR USE ON: CHEVROLET OPTRA</p>
<p>IRDC-018 12V.</p>   <p>P L DFM B-Circuit Voltage Set Point 14.50V Soft Start 30% LRC 5 sec Field Shorted Circuit Protection Under Voltage Indication Over Voltage Indication DFM Function</p>	<p>IRDC-019 12V.</p>   <p>P L X B-Circuit Voltage Set Point 14.70V Soft Start 30% Field Shorted Circuit Protection Under Voltage Indication Over Voltage Indication Self Exciting Function FOR USE ON: 11SI Alternator</p>	

REGULATORS HITACHI

<p>IRHI-1Z27 12V.</p>  <p>NISSAN 23215-B9800, 23125-F2500,23215-P2500, 23215-Q4601,2315-Q4602</p> <p>HITACHI TR1Z-27,TR1Z-33, TR1Z-47,TR1Z-48, TR1Z-56,TR1Z-65 NEW-ERA IVR 801 WAI 35-8100,35-8114 TRANSPO IH210</p> <p>B S L F E</p>	<p>IRHI-1Z43 12V.</p>  <p>NISSAN 23125-W1700, 23125-W1701 HITACHI TR1Z-43,TR1Z-53, TR1Z-62, TR1Z-64,</p> <p>MAZDA RF01-24-520 ISUZU 8-94250-964-0 8-94237-728-0, 8-94155-308-5 NEW-ERA IVR 806 WAI 35-8101 TRANSPO IH212</p> <p>B S R L F E</p>	<p>IRHI-1Z44 12V.</p>  <p>HITACHI TR1Z-44,TR1Z-63 LR120-15C, LR120-23, LR135-58B, LR135-86F ISUZU 5-00181-010-0, 5-81200-338-0, 5-81200-338-1 5-81270004-0 NEW-ERA IVR 804 TRANSPO</p> <p>R R L F E</p>
<p>IRHI-1Z46 12V.</p>  <p>ISUZU 8-94223-967-0 ISUZU 8-94221-451-4 HITACHI LR140- 112 HITACHI TR1Z-46 NEW-ERA IVR 803 TRANSPO IH214</p> <p>R S B F E</p>	<p>IRHI-1Z64 12V.</p>  <p>HITACHI TR1Z-64, TR1Z-64A LR170-402E, LR170-404B, LR170-406B</p> <p>NISSAN 23100-G5701, 23100-V7204,23215-W1701, 23215-54A00,23100-54A02 NEW-ERA IVR 805 WAI 35-8101 TRANSPO IH717</p> <p>B S R L F E</p>	<p>IRHI-2Z37 24V.</p>  <p>ISUZU 8-94156-595-0, 8-94122-267-3, 8-94336-728-0 NISSAN 23215-C6800</p> <p>HITACHI LR225-408E, LR225-409B,LR225-4418B, TR2Z-37,TR2Z-49 NEW-ERA IVR 760 TRANSPO IH716</p> <p>B S R L F E</p>
<p>IRHI-2Z47 24V.</p>  <p>NISSAN 23500-99008, 23099-Z5518, 23099-Z5560 HITACHI TR2Z-47, LR215-50, LR220-23, LR220-24 ISUZU 5- 81251-016-0 NEW-ERA IVR 761 TRANSPO IH707</p> <p>R R L F E</p>	<p>IRHI-0400(IRSW-0400) 24V.</p>  <p>NISSAN 23500-99005 HINO 27700-1510, 27700-1370 SAWAFUJI 1219-004-00, 1219-005-00 TOSHIBA S5476A TRANSPO IH708</p> <p>R L F C E</p>	<p>IRHI-13544 12V. S - L TERMINALS</p>  <p>HITACHI LR135-44 WAI 35-8100 35-8114 TRANSPO IH201</p>
<p>IRHI-15515 12V. S - L TERMINALS</p>  <p>HITACHI LR155-15, LR160-137 TRANSPO IH202</p>	<p>IRHI-135-43153 12V.</p>  <p>HITACHI</p>	<p>IRHI-150-43151 12V. S - L TERMINALS</p>  <p>HITACHI L150-43151, L150-63151, L150-73301, LR150-98E, LR150-99B</p> <p>NISSAN 23125-P3005 23135-Q4601,23133-W1606, 23133-W7101,23100-H7703 WAI 35-8134 TRANSPO IH203</p>
<p>IRHI-2Z49 24V.</p>  <p>HITACHI TR2Z 49, LR270-05 NISSAN 23100-17D60, 23215-C6800 TRANSPO IH253</p> <p>IG L SL</p>	<p>IRHI-150-33155 12V.</p>  <p>HITACHI LR150-421C, LR150-431, LR150-438B, L150-33155,</p> <p>ISUZU 8-94167-410-0, 8944527390,894490540 TRANSPO IH252</p> <p>IG L S</p>	<p>IRHI-160-412 12V.</p>  <p>HITACHI TRANSPO IH254</p> <p>IG L S</p>
<p>IRHI-772 12V.</p>  <p>HITACHI LR160630C, LR160729C, LR160730C LR160731</p> <p>ISUZU 2 9027 6 6000, 8 9710 1 8162, 89712 0 7520, 8 9713 0 7760 TRANSPO IH772</p> <p>S L C IG</p>	<p>IRHI-150-93155 12V.</p>  <p>HITACHI LR140-419, LR140-421, LR140-436S, LR150-425, LR150-428, LR150-430, L150-93155,L160-23153 TRANSPO IH205</p> <p>NISSAN BIG-M</p> <p>L S</p>	<p>IRHI-170-3315 12V.</p>  <p>NISSAN 23100-02E00, 23100-02E05, 23133-13E00 HITACHI L170-3315, LR160-708, LR160-709 TRANSPO IH250</p> <p>L S</p>

REGULATORS HITACHI

IRHI-170-43151 12V.



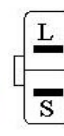

NISSAN 23100-77A00,
23133-77A00
HITACHI LR165-707,
LR165-707B,
L170-43151
TRANSPO IH245

IRHI-180-7315 12V.

NISSAN 23100-16E05,
23100-26E61,
23100-34E01,
23133-26E60
HITACHI LR180-704
LR180-721B, L180-7315
LR190-704B, LR190-711
TRANSPO IH238

IRHI-190-3315 12V.

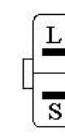
NISSAN 23100-26E05,
23100-26E60,
23100-34E00,
23133-F6100
HITACHI LR170-704
LR170-713, LR170-721,
LR190-704, LR190-3315
TRANSPO IH239

IRHI-744 12V.



HITACHI LR190744
ISUZU 2 9027 6 8300,
8 9720 4 3320
TRANSPO IH744

IRHI-758 12V.

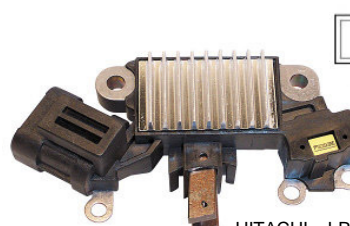
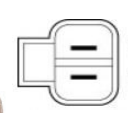
HITACHI LR170-758
MAZDA BP4W-18300C
TRANSPO IH758

IRHI-769 12V.



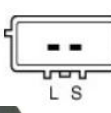

HITACHI LR 170-509E
1100-502E
1100-502E
TRANSPO IH769

IRHI-774 12V.

CARGO 231534
HITACHI 8037
MOBILETRON MFVR03800
L1100G-8340
VR-H2000-46 L1100G-53402
TRANSPO IH774

IRHI-765 12V.

NISSAN 23100-70F00
23100-70F05
TRANSPO IH765

HITACHI LR180Z42C,
LR185701H,
LR185702,
LR190724

IRHI-766 12V.

HITACHI L1100G-3340
L1110G-9340
L1125G-1340
NISSAN 23215-31U05
TRANSPO IH766

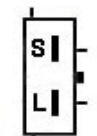
IRHI-776 12V.



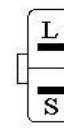

HITACHI L170G-7315,
L170G-3319,
L170G-6308,
LR170G-7315
ISUZU 8971226430
TRANSPO IH776

IRHI-17033152 12V.

NISSAN 23215-50Y05,
23100-0E700,
23100-0E705,
23100-50Y05
HITACHI L170-33152
LR165-708B,
LR170-738B,
TRANSPO IH760a

IRHI-180G2340 12V.

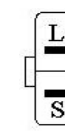
NISSAN 23215-85L00,
23100-0E700
TRANSPO IH761

HITACHI L180G-2340,
LR165-708C,
LR738C,
LR180-731B

IRHI-738 12V.

HITACHI LR1100709B,
LR1100722,
LR170757B,
LR180756B
NISSAN 23100-3S500
23100-4S100,
23100-5M000
23100-9E000
TRANSPO IH738

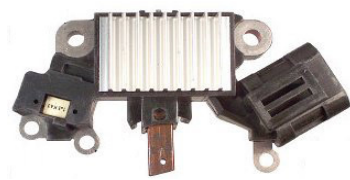
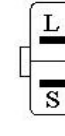
IRHI-767 12V.



HITACHI L170G6315
L170G5315
L 180G23401
NISSAN 2202085M10

IRHI-180G5340 12V.



NISSAN 23215-64J00,
23100-64J01
TRANSPO IH762

HITACHI LR180G-5340
LR160-724,
LR160-727,
LR180-725,
LR180-725B

IRHI-8315 12V.



HITACHI LR180-8315
LR160-723,
LR160-734,
LR170-739,
LR180-725
NISSAN 23215-64J00
TRANSPO IH248

CTIRHI-33155
HIR-252



HITACHI L150-33155
ISUZU 8-94167-410-0
NISSAN 23215-C6800

ISUZU TER







CTIRHI-93155
HIR-205















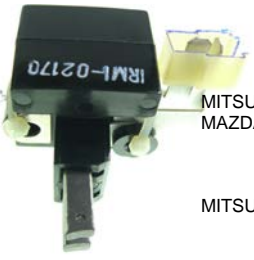
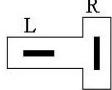

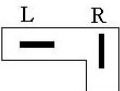

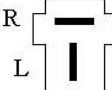





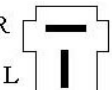

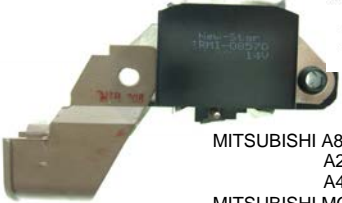
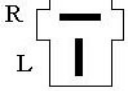

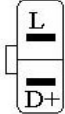

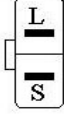

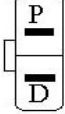
HITACHI L150-93155
L160-23153
LR140-419,421,436S
LR150-725,428,430

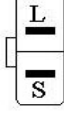
NISSAN BIG M

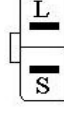
REGULATORS HITACHI

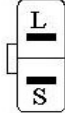
<p>IRHI-409 12V.</p>  <p>VOLTAGE SET POINT : 14.3 V REGULATION : A-CIRCUIT</p>	<p>IRHI-1140 24V.</p>  <p>VOLTAGE SET POINT : 28.5 V REGULATION : A-CIRCUIT HITACHI 8-9711264-6</p>	<p>IRHI-1140-3 12V.</p>  <p>VOLTAGE SET POINT : 14.6+ 0.3 V REGULATION : A-CIRCUIT USE FOR : ISUZU 2.8 TB</p>
<p>IRHI-160-43154 12V.</p>  <p>HITACHI UCJ126 L16043154 Nissan200SX,240X,Axxess, L17053151 Pulsar,Sentra LUCAS 21511109</p>	<p>IRHI-5042D-MAX</p>  <div style="text-align: right; border: 1px solid black; padding: 2px; width: 30px; float: right;"> L — S </div> <p>D-MAX 2500 + PUMP</p>	<p>IRHI-739 24V.</p>  <div style="text-align: right; border: 1px solid black; padding: 2px; width: 30px; float: right;"> L — S </div> <p>HITACHI LR280-508 ISUZU 8972489141</p>
<p>IRHI-20036 12V.</p>  <div style="text-align: right; border: 1px solid black; padding: 2px; width: 30px; float: right;"> L — R </div> <p style="text-align: center; margin-top: 10px;">B S R L F E</p> <p>MOBILETRON VR-H2000-36 CARGO 132432</p>		

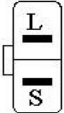
REGULATORS MITSUBISHI

<p>IRMI-01070 24V.</p>  <p>MITSUBISHI A866T01070 MITSUBISHI Motors ME007396, ME007396, ME007397, ME007550 MITSUBISHI A2T61571, A2T61871, A2T61971, A2T70571 TRANSPO IM215</p>	<p>IRMI-02370 24V.</p>  <p>MITSUBISHI A866X02370 A1T70379, A2T70879 MAZDA SE 01-24-520 SE 01-18-300C, SE01-18-300D TRANSPO IM214</p>	<p>IRMI - 02170 12V.</p>   <p>MITSUBISHI A866X02170 MAZDA 8599-24-520, 8599-18-300, S241-18-300, S241-18-300A MITSUBISHI A1T23479, A1T32779, A2T25470 TRANSPO IM224</p>
<p>IRMI-02470 12V.</p>   <p>MITSUBISHI A866X02470 A1T23579, A1T31179 MAZDA S501-24-520 S202-18-300A, S203-18-300 TRANSPO IM226</p>	<p>IRMI-00670 12V.</p>   <p>MITSUBISHI A866T00670, A866T01970, A866T02570, A866T02770, A866T03270, A866T00470 FORD E27Z-10316-A, MAZDA 8173-24-520, N221- 24-520 TRANSPO IM204</p>	<p>IRMI-00870 12V.</p>   <p>MITSUBISHI A866T00870, A866T02270, A866T02970, MAZDA 8574-24-520 NISSAN 23215-P3017, 23215-W7110 TRANSPO IM225</p>
<p>IRMI-03070 12V.</p>   <p>MITSUBISHI A866T03070 MITSUBISHI MOTORS MD607619 MAZDA 4813-18-300 TRANSPO IM205</p>	<p>IRMI-06570 12V.</p>   <p>MITSUBISHI A866T06570 TRANSPO IM207 FOR : MITSUBISHI CANTER</p>	<p>IRMI-06670 24V.</p>   <p>MITSUBISHI A866T06670 MITSUBISHI MOTORS ME049165, ME017560, ME017561, ME007578 TRANSPO IM213 A5T70178, A5T70183, A5T70283</p>
<p>IRMI-06870 24V.</p>   <p>MITSUBISHI A866T06870 A2T72286, A4T57789 MITSUBISHI MOTORS ME700635, ME017563, ME017588, ME037640 TRANSPO IM212</p>	<p>IRMI-26070 24V.</p>   <p>MITSUBISHI A866X26070, A866X26072, A4TU3085 A4TU3088, A4TU3186 MITSUBISHI MOTORS ME 701302 , ME 093256 TRANSPO IM843</p>	<p>IRMI-20472 12V.</p>   <p>MITSUBISHI A866X20472 MAZDA B64J-18-W70, JE48-18-W70, B366-18-300 TRANSPO IM830</p>
<p>IRMI-345 12V.</p>   <p>MITSUBISHI A2TB0091 MAZDA 599-18-300 AKIA TRANSPO IM345 FOR : MAZDA, KIA</p>	<p>IRMI-350 12V.</p>   <p>MITSUBISHI VR 350 A2TA 7691 SUBARU 23700-AA290 TRANSPO IM350</p>	<p>IRMI-12770 12V.</p>   <p>MITSUBISHI A866X12770, A866X12772, A2T05772 MAZDA B675-18-W70, B675-18-300A, B675-18-300B TRANSPO IM265</p>
<p>IRMI-25572 12V.</p>   <p>MITSUBISHI A866X25572 MD 618735 MD 619167 TRANSPO IM847 FOR: STRADA, FUSO CANTER, MAZDA</p>	<p>IRMI-28372 24V.</p>   <p>MITSUBISHI A866X28372 ME 701399 TRANSPO IM846</p>	<p>IRMI-849 24V.</p>  <p>MITSUBISHI</p>

REGULATORS MITSUBISHI

IRMI-09171 12V.

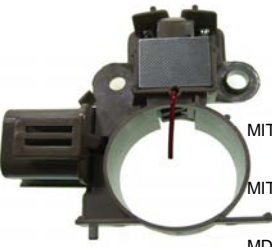
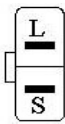
MITSUBISHI A866X09171
A2T01384 ,
A2T01483
MITSUBISHI Motors

MD 611481 , MD 102864,
MD 102865 , MD 103372,
TRANSPO IM281

IRMI-46572 12V.

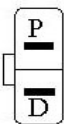

MITSUBISHI
A866X46572
GY01-18-W70,
W9XA
MAZDA
GY01-18-300R
TRANSPO IM465

IRMI-224 12V.

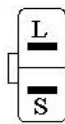

MITSUBISHI
A2T33593
NISSAN
23100-0P515
TRANSPO
IM292

IRMI-13272 12V.

MITSUBISHI
A866X13272
A2T02394,
A2T14694
NISSAN
23215-35F10
TRANSPO IM284

IRMI-27572 12V.

MITSUBISHI
A866X27572
RATERO
NEW-ERA
IVR943

IRMI-22272 12V.

STRADA
2800

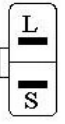
IRMI-00189 12V.

MITSUBISHI 189,
A5T02377
MAZDA F2G8-
18-300
TRANSPO IM829

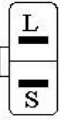
IRMI-17072 12V.

MITSUBISHI
A866X17072
A2T13977,
A2T18177,
A2T18277,
A2T19877

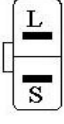
MITSUBISHI MOTORS
MD150657
TRANSPO IM280

IRMI-21072 12V.

MITSUBISHI
A866X21072
A2T132899
FORD
F2JY-10346A
TRANSPO IM837

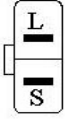
IRMI-05272 12V.





MITSUBISHI
A866X05272,
A866X09071,
A866X09771
MITSUBISHI MOTOR
MD 611432,
MD 611565
NISSAN 23125-04P10
TRANSPO IM217

IRMI-09780 12V.



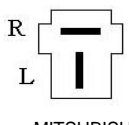

MITSUBISHI
A866T09780,
A866T09782
NISSAN 23124-53A10
HYNDAI 37300-33010,
37300-33030,
37300-33013
TRANSPO IM831

IRMI-04872 12V.

MITSUBISHI
A866X04872 ,
A866X05471,
A866X05472
MAZDA FE65-24-520
FORD E8GY-10346-A
MITSUBISHI MOTORS
MD 611032
TRANSPO IM216

IRMI-853 12V.

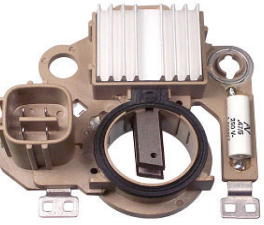
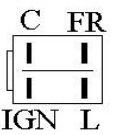
MITSUBISHI
VR438
HONDA
AHGA35
TRANSPO
IM853

IRMI-2009 12V.



VOLTAGE SET
POINT : 14.4 V.
REGULATION : A-
CIRCUIT

IRMI-03200 12V.



MAGNETIMARELLI
940 038 102
MITSUBISHI
232
MITSUBISHI
A 866 X 23200

IRMI-08871 24V.



MITSUBISHI
A866X08871
A866X19972
MOBILETRON
MFVR02871

IRMI-17170 12V.







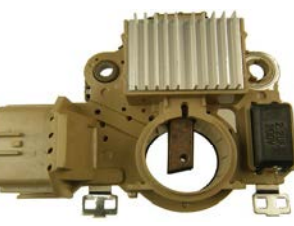

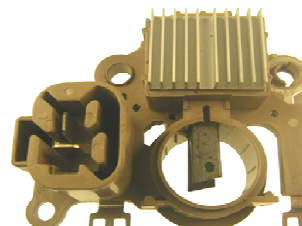

CARGO
134026
HUCO
132922
MADNETI
MARELLI
940 038 100
MITSUBISHI
A866X17170
A866X17172
B36618W70
MOBILETRON
VR-H2009-24
Mazda Protege

IRMI-34172 12V.



MITSUBISHI
A 866 X 34172
MOBILETRON
MFVR02880
VR-H2009-70A

REGULATORS MITSUBISHI

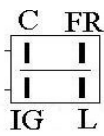
<p>IRMI-023772 12V.</p>  <p>CARGO 139667 MITSUBISHI 237 A866X23772 MOBILETRON VR-H2009-44 WAI 35-8342</p>	<p>IRMI-26172 12V. IRMI-0127172</p>  <p>MITSUBISHI A866X22272 MD618696 AZT34892 MD618569</p>	<p>IRMI-47301 12V.</p>  <p>A-Circuit O.E.M NO.: HYUNDAI 37370-47301 Voltage Set Point: 14.5V HYUNDAI STAREX (110A)</p>
<p>IRMI-073 24V.</p>   <p>Regulator for Mando TRUCK Replaces: TA500C06001C Wil Corporation Ref. P7004 KEY FEATURES: A-circuit, Volt Set 28.5 V</p>	<p>IRMI-056 12V.</p>  <p>A-Circuit Voltage Set Point 14.50V ALTERNATOR REFERENCES HYUNDAI 3730042451 MANDO AF175363</p> <p>HYUNDAI</p>	<p>IRMI-0851 12V.</p>  <p>STRADA 2800</p>
<p>IRMI-8300B 12V.</p> 	<p>IRMI-851-1 12V.</p>   <p>A-Circuit Voltage Set Point 14.50 V Soft start 30% LRC 5sec DFM function TRANSPO IM851</p>	